



Operating Manual

SONO-PR 200

Broadband ultrasonic pulser-receiver for nondestructive testing

Translation of the German Original

Revision: 2.0 | 2022-10-14

Content

1	Introduction.....	4
1.1	Notes on this documentation.....	4
1.2	Representations in this documentation	4
1.3	Identification of warning instructions.....	5
2	Safety instructions	6
2.1	Introduction.....	6
2.2	Basic hazards.....	7
2.3	Personnel and qualifications	8
2.4	Safety-conscious working practices.....	9
2.5	Use of the product	9
2.6	Modifications and alterations.....	9
3	Description of the device	11
3.1	Intended use	11
3.2	Prohibited use.....	11
3.3	Scope of delivery.....	12
3.4	Device labeling	13
3.5	Front side of the device.....	14
3.6	Back side of the device	15
3.7	Touch screen	16
3.7.1	Main menu	16
3.7.2	Settings	19
3.7.3	Setups	20
3.7.4	Brightness.....	21
3.8	RS-232 interface	22
3.8.1	RS-232 settings	22
3.8.2	Commands.....	22
3.8.3	Queries	24
3.8.4	Parameter dependencies	26
4	Preparing a work order	27
4.1	Positioning.....	27
4.2	Connecting external devices	28
4.3	Adjusting the brightness of the touch screen.....	30
4.4	Setting the signal trigger	30
4.5	Setting the operation mode	32
4.6	Setting the transmitter pulse type.....	33
5	Performing a work order.....	34
5.1	Connecting a probe (SONOTEC probes)	34
5.2	Setting up parameters	36
5.3	Saving settings	37

5.4	Overwriting an existing setup	38
5.5	Loading settings	39
6	Maintaining the system	40
6.1	Replacing fuses	40
6.2	Cleaning.....	41
6.3	Maintenance	41
7	Technical data	42
8	Disposal.....	45
9	Warranty	46
10	Manufacturer information	47

1 Introduction

This section is intended to explain function, structure and representations of the document to simplify handling of the document.

1.1 Notes on this documentation

Purpose

This document constitutes an integral part of the product and contains important advice on safe operation as well as all information on intended and efficient use. Thus, any person using the product must have read and understood this document.

Accessibility

The staff working with this product must have constant access to this document to prevent handling errors and guarantee trouble-free operation.

Up-to-dateness

Every effort has been made to ensure that the information contained in this document is complete and correct at the time of release. This document describes all units and functions known of at the current point of time.

1.2 Representations in this documentation

Illustrations

Illustrations used in this document do not always contain all details or special cases. They only represent the relevant information.

Tips

Tips are marked as follows:

 Tips describe specific information or particular features that might not be evident, even for experienced users. The neglect of a tip poses no direct safety risk. However, it can lead to workflow disruptions.

General icons

The following general icons are used for visual emphasis:

Icon	Function
	Indicates a link to external content.

1.3 Identification of warning instructions

Classes of danger, signal words and colors

This document contains warnings regarding hazards of different classifications. These classes are characterized by signal words and colors. They include the following:

DANGER

Warns of immediate danger, which, if ignored, may lead to death or serious injury.

WARNING

Warns of possible immediate danger, which, if ignored, may lead to lasting damage to health and/or property - including financial losses due to operational impairment.

ATTENTION

Warns of dangers, which, if ignored, may lead to damage to property – including damage to property due to operational interruptions.

2 Safety instructions

This section contains safety information relating to the protection of persons as well as safe and fault-free operation. All user groups of the product must be aware of and follow these safety provisions.

2.1 Introduction

Reliable and safe operation of the product depends on the careful handling and execution of operational and setting tasks.

Ignoring these safety instructions and warning information may lead to serious injury with lasting health consequences for personnel as well as damage or destruction of product components.

During handling of the product, please observe all safety instructions and warning information in all parts of this user documentation as well as the related codes of practice. Ensure that all those working with the product are also aware of these instructions.

Generally applicable safety regulations (such as accident prevention and environmental protection regulations, etc.) must also be observed.

2.2 Basic hazards

Definition

Basic hazards are residual risks that remain even with safety-conscious intended use.

State of the art

The product meets the current state of the art and applicable safety rules. All components of the product are tested thoroughly before they leave the factory and are delivered in a condition for safe operation.

WARNING

Danger of injury!

Improper use of the device may lead to injuries.

- Do not open the device.
- Protect the device against extreme heat (excessive sunlight, immediate vicinity of open fire or heating devices) during operation and storage.
- Avoid strong impacts that could damage the device and/or its components.

ATTENTION

Possible damage of the device display!

Improper use may damage the device display.

- Do not use scratching or sharp objects to operate the device by touch screen. Commercially available pens for touch screens are suitable.

2.3 Personnel and qualifications

Basic requirements

The product must only be used by operators that have completely read and understood the safety instructions and all documents of the user documentation.

Personnel undergoing training or instructions or persons taking part in general vocational training programs may only operate the device under the continuous supervision of operating or technical personnel.

Responsibility of the operating company

Regarding the personnel authorized and/or trained by the operating company, the operating company carries the following responsibilities:

- The necessary training and instruction of personnel must be guaranteed.
- All personnel's competences and responsibilities must be clearly stated and documented.
- All user information on the product (operating manual, user documentation etc.) must be kept in the immediate vicinity of the product and must be accessible at all times.

Requirements for ultrasonic testing

Operators must have thorough expertise, skills and experience to avoid errors that may lead to unforeseeable consequences. SONOTEC recommends that operators should undergo professional ultrasonic testing training according to applicable regulations.

Nondestructive ultrasonic testing may only be carried out when the following (minimum) conditions are met:

- Selection of a suitable probe
- Complete and correct configuration of the device parameters
- Selection of a suitable testing method
- Correct interpretation of the generated echoes

Configuring the parameters and evaluating the test results require thorough knowledge of the dissemination in space and time of ultrasound in a range of materials, the behavior of ultrasonic waves at limit surfaces – such as material flaws or transition zones – and the capabilities of ultrasonic equipment to optimally display echo patterns.

2.4 Safety-conscious working practices

Accident prevention and environmental protection

In addition to the instructions in this operating manual, please mind the generally applicable legal and other regulations on accident prevention and environmental protection.

This may include, for example:

- Handling of hazardous materials
- Wearing the required and mandatory personal protective clothing and safety equipment
- Observing of and complying with all national and regional industrial safety regulations
- Observing of and complying with all internal working, operating and safety regulations

2.5 Use of the product

General use

Improper use of the product may lead to injuries of operating personnel and/or product damage. Damaged components may affect or distort the measurement result quality.

- During use, charging and storage, protect the device against extreme, unusual heat (excessive sunlight, storage in heated cars or immediate vicinity of open fire or heating devices). It is critical to stay within the temperature ranges given in the technical specification.
- Do not use the product and its accessories if they display functional errors and/or visible damage.
- Only connect the product to approved equipment received from SONOTEC GmbH or its sales partners.
- Handle the product with care and protect it against major shocks.
- Do not use the product within strong electromagnetic fields.
- Do not use scratching or sharp objects to operate the touchscreen. Apart from operation by finger touch, commercially available touchscreen pens or touchscreen gloves are suitable.

Functionality of safety and protective devices

The full functionality of all safety and protective devices must be ensured at all times. All equipment must regularly be checked for full functionality and completeness.

This applies to the device as single component as well as an overall system into which the device is integrated as a component.

2.6 Modifications and alterations

No modifications on the product and/or accessories

The product and/or its accessories must not be opened or disassembled. The product does not contain any components to be cleaned, maintained or repaired by operators.

Unauthorized modifications of the product and/or its accessories are prohibited and lead to exclusion of liability by the manufacturer for resulting damage and consequences.

Spare parts and accessories

Spare parts and accessories must comply with the technical requirements specified by SONOTEC GmbH and its suppliers. Whenever original parts are used, compliance is given.

No alterations to the software

Do not alter the supplied software or commission software alterations to third parties. The software may not be disassembled, decrypted or decompiled in full or in part.

3 Description of the device

This section describes use, connections and operating elements of the SONO-PR 200.

3.1 Intended use

The SONO-PR 200 is a high-performance broadband pulser-receiver and intended for the following applications:

- Nondestructive measurement/examination of wall thickness
- Nondestructive material testing
- Probe specification in R&D
- Immersion and squirter applications
- Acoustic microscopy
- Integration into automated testing systems

3.2 Prohibited use

Any use not approved by SONOTEC GmbH is prohibited and may lead to injury or damage to property.

SONOTEC GmbH accepts no liability for damage caused by prohibited use of the product.

Prohibited are in particular:

- Use of equipment and/or accessories with visible damage
- Use in wet rooms
- Use in potentially explosive environments
- Use in environmental conditions that do not adhere to the stipulated requirements
- Unauthorized modifications of the equipment, the software and/or accessories
- Use of unauthorized spare parts and/or unauthorized accessories

Operating or using the product incorrectly and/or not in the sense of its intended use may lead to risk of death and personal injury.

3.3 Scope of delivery

The following components are part of the scope of delivery:

- SONO-PR 200 (configuration depending on the specific order)
- Power cord
- Operating Manual

The following configurations are available:

Designation	Article number
SONO-PR 200 Spike Pulser – Rack mount	200 09 0001
SONO-PR 200 Spike Pulser – Desktop	200 09 0009
SONO-PR 200 Combi Sender – Desktop	200 09 0015
SONO-PR 200 Combi Sender – Rack mount	200 09 0016

Optional

Designation	Article number
SONO-AMP Set (low noise pre-amplifier including power coupler)	700 01 0398

3.4 Device labeling

Identification plate

The identification plate is located on the back side of the device. Please keep the data on the identification plate ready whenever you contact customer service.

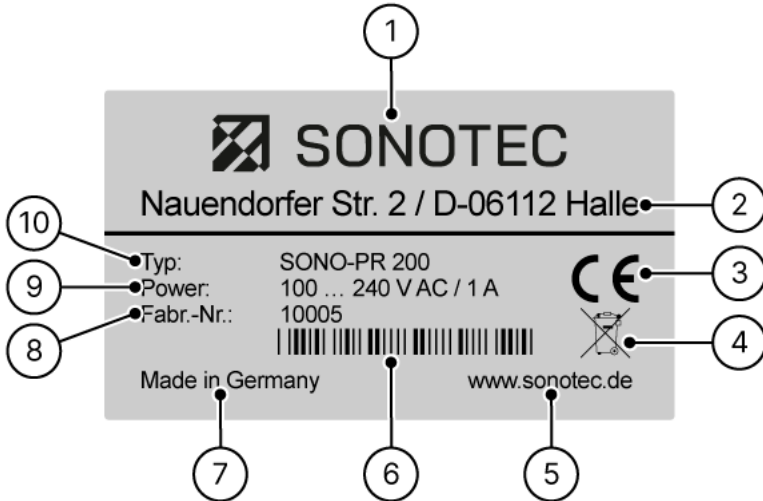

Figure 1: Identification plate with its components

Nr.	Identification
1	Name of manufacturer
2	Manufacturer's address
3	CE marking
4	Disposal symbol (see "8 Disposal", page 45)
5	Manufacturer's website
6	Bar code
7	Country of origin
8	Serial number
9	Power rating
10	Device designation

3.5 Front side of the device

Structure

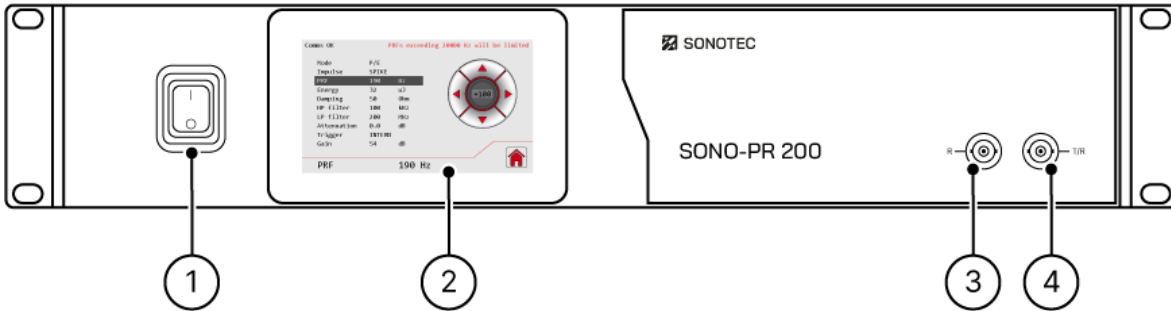

Figure 2: Front side of the device with its components

Description

No.	Component
1	On/off switch
2	Touch screen (see "3.7 Touch screen", page 16)
3	Probe output (receiver)
4	Probe output (transmitter/receiver)

3.6 Back side of the device

Structure

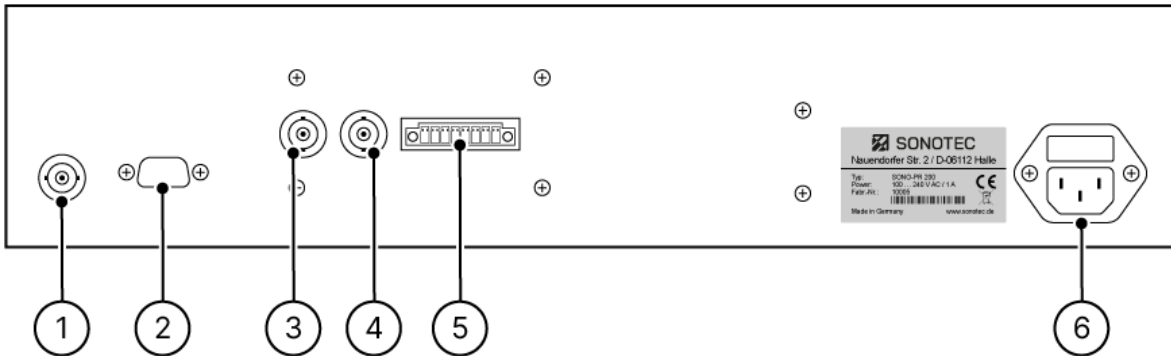

Figure 3: Back side of the device with connections

Description

No.	Component
1	Analog HF Out <ul style="list-style-type: none">Analog high frequency signal outputType: BNC connector
2	RS-232 interface <ul style="list-style-type: none">Connector for computer interfaceType: 9 pin D-sub male
3	Trigger In <ul style="list-style-type: none">Trigger signal inputType: BNC connector
4	Trigger Out <ul style="list-style-type: none">Trigger signal outputType: BNC connector
5	Digital I/O <ul style="list-style-type: none">Digital inputs and outputsType: Phoenix MCV 1,5/ 8-GF-3,81
6	Mains voltage with fuses <ul style="list-style-type: none">110/220 VAC, 1 A, 50/60 HzType: C14 maleFuses: 2, replaceable, type T1A (1 A, 250 V)

3.7 Touch screen

The touch screen is used to set the parameters of SONO-PR 200. This section describes the screens individual of the touch screen.

3.7.1 Main menu

Function

The “Main menu” screen contains a list of all configurable parameters as well as functions for saving and loading settings.

Structure

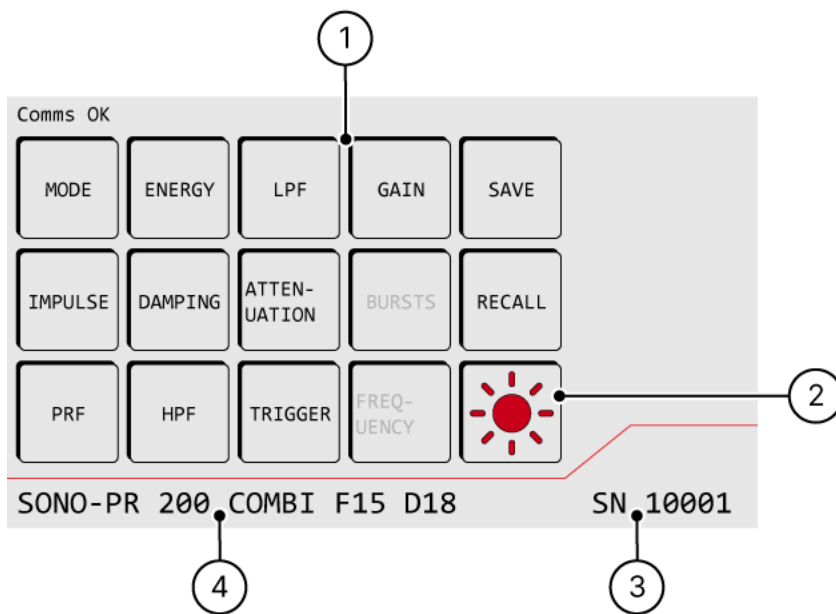

Figure 4: “Main menu” screen with components

Description

No.	Type	Description/function
1	Parameter	Shows buttons for all parameters. Tapping a parameter button opens the “Settings” screen for customizing the respective parameter. <div style="border: 1px solid black; padding: 5px; margin-top: 5px;">① Parameter availability depends on the device configuration and/or current device settings. Unavailable parameters will be grayed out.</div>
	Mode	Setting the operation mode: P/E (Pulse/Echo) T/R (Transmitter/Receiver)
	Energy	Setting the energy output of the pulser output in the following steps:

No.	Type	Description/function
		1 2 4 8 16 32 μ J <div style="border: 1px solid black; padding: 2px;"> ⓘ Available for "SPIKE" pulse only.</div>
	Voltage	Setting the pulser output voltage: <ul style="list-style-type: none"> • in "P/E" mode: 10 ... 100 V (in 10 V increments) • in "T/R" mode and 50 Ω impedance: 10 ... 100 V (in 10 V increments) • in "T/R" mode and 1 kΩ impedance: 20 ... 200 V (in 20 V increments) <div style="border: 1px solid black; padding: 2px;"> ⓘ Available for "RECT" pulse only.</div>
	LPF	Setting the low-pass filter: 200 MHz 100 MHz 50 MHz 20 MHz
	Gain	Setting the receiver signal gain in the following steps: 26 40 54 dB
	Save	Saving all current settings as a specific setup. Opens the "Setups" screen.
	Impulse	Setting the pulse type: <ul style="list-style-type: none"> • RECT (unipolar-) • RECT (unipolar+) (optional) • RECT (bipolar) (optional) • SPIKE (peak)
	Damping	Setting the pulser output impedance in Ω .
	Attenuation	Setting the receiver signal attenuation: Range: 0 ... 65.5 dB Increment: 0.5 6 dB
	Bursts	Setting the number of pulse repetitions: Range: 1 ... 10 impulses <div style="border: 1px solid black; padding: 2px;"> ⓘ Available for "RECT" pulse only.</div>
	Recall	Loading saved settings. Opens the "Setups" screen.
	PRF	Setting the pulse repetition frequency (frequency of generated pulses) for internal signal trigger: Range: 10 Hz ... 20 kHz Increment: 10 100 1000 Hz
	HPF	Setting the high-pass filter. 100 kHz 1 MHz 3 MHz 10 MHz

No.	Type	Description/function
	Trigger	Switching the signal triggering mode: INTERN (internal trigger – PRF) EXTERN (external trigger)
	Frequency (Width)	Setting the pulse width: Range: 63 ... 1000 ns <div style="border: 1px solid black; padding: 2px; margin-top: 5px;"> ⓘ Available for “RECT” pulse only.</div>
2	Brightness	Adjusting screen brightness. Opens the “Brightness” screen.
3	Serial number	Shows the device's serial number.
4	Device configuration	Shows the device name and configuration (Spike or Combi).

ⓘ Automatic constraint of pulse repetition frequency (PRF)

When using the “RECT” pulse type, it will not be possible to simultaneously set maximum values for “Voltage”, “Damping”, “Burst”, “Width” and “PRF”. Depending on the particular settings, the software will automatically constraint the PRF. The maximum permissible PRF for the current parameter settings is displayed the “Settings” screen.

3.7.2 Settings

Function

The “Settings” screen is used to set parameter values.

Structure

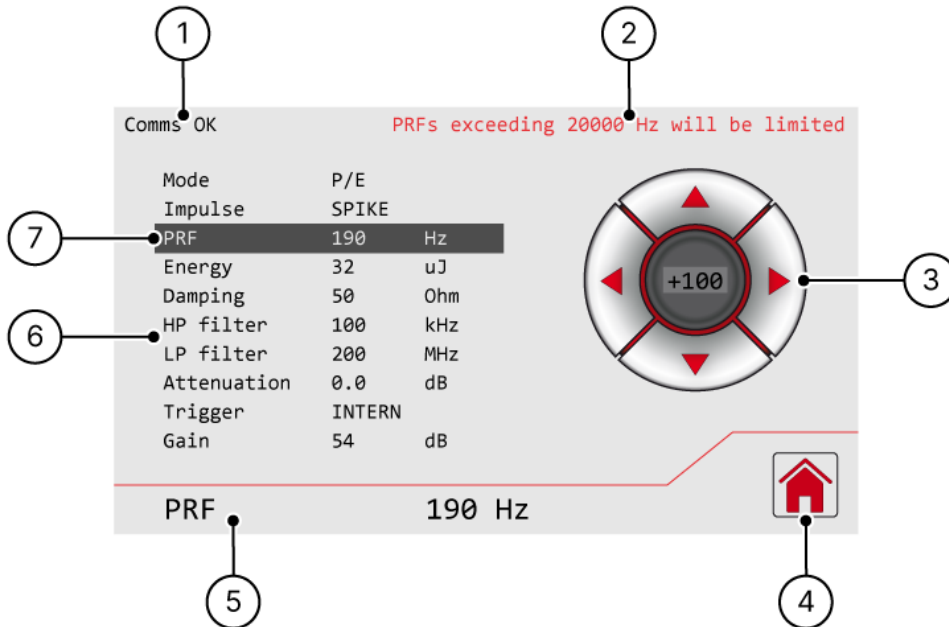

Figure 5: “Settings” screen with components

Description

No.	Type	Description/function
1	Device communication status	<ul style="list-style-type: none"> OK: Device communication okay NOK: Device communication faulty
2	PRF constraint	Shows the maximum permissible pulse repetition frequency (PRF) of the current configuration.
3	Directional pad	<ul style="list-style-type: none"> Top and bottom buttons: navigation between settings Left and right buttons: adjusting the selected parameter value Center button: setting the increments for PRF or attenuation
4	Home	Switching to the “Main menu” screen
5	Current setting	Shows the currently selected setting.
6	Parameter list	List of available settings with currently set values.
7	Current setting	Shows the currently selected setting.

3.7.3 Setups

Function

In the “Setups” screen, all set parameters may be saved as one specific setup. In total, 15 setups may be saved. Existing setups may be overwritten with new settings.

Structure

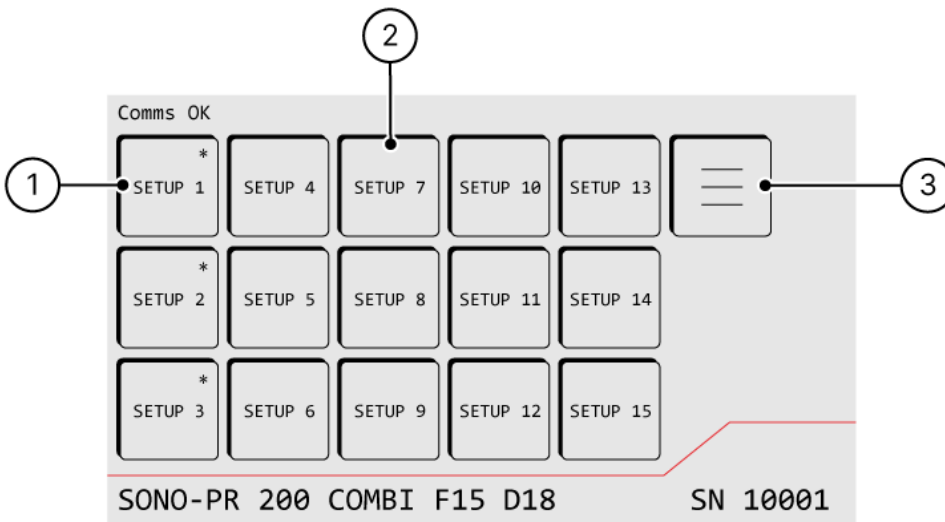

Figure 6: “Setups” screen with components

Description

No.	Type	Description/function
1	Assigned setup	Setup with saved settings.
2	Available setup	Setup without saved settings.
3	Home	Switching to the “Main menu” screen

3.7.4 Brightness

Function

In the “Brightness” screen, the brightness of the touch screen may be adjusted.

Structure



Figure 7: “Brightness” screen with components

Description

No.	Type	Description/function
1	Home	Switching to the “Main menu” screen
2	Increasing brightness	Increasing brightness of the touch screen.
3	Decreasing brightness	Decreasing brightness of the touch screen.

3.8 RS-232 interface

The SONO-PR 200 may be controlled by a personal computer via the RS-232 interface. Currently set parameters may be read out and modified.

This section describes the RS-232 interface of the SONO-PR 200.

3.8.1 RS-232 settings

Description

The following settings are defined for the RS-232 interface:

- baud rate 9600
- 8 bit
- 2 stop bits
- No parity

3.8.2 Commands

Description

The RS-232 interface may be used to send commands for setting the SONO-PR 200's parameter values.

Responses

After sending a command, the SONO-PR 200 will return one of the following responses:

Command type	Response
Valid	OK\r\n
Invalid	ER\r\n

Syntax

For sending a command, the following syntax must be used for parameter and parameter value (**x**):

PARAMETER=x\r\n

Available commands and parameter values

The following table contains a list of all available parameters and the respective parameter values:

Command	Description	Available parameter values
DG=x\r\n	Sets the damping in Ω	x = 7, 10, 16, 20, 26, 30, 40, 50

Command	Description	Available parameter values
EY= x\r\n	Sets the energy in μJ ⓘ Available for "SPIKE" pulse only.	x = 1, 2, 4, 8, 16, 32
GN= x\r\n	Sets the gain in dB	x = 26, 40, 54
HF= x\r\n	Sets the high pass filter [HPF] in kHz*	x = 100, 1000, 3000, 10000
IA= x\r\n	Sets the input attenuation in dB	x = 10.0, 20.0, 30.0, 40.0, 50.0
OA= x\r\n	Sets the output attenuation in dB	x = 00.0, 00.5, ... 15.5
LF= x\r\n	Sets the low pass filter [LPF] in MHz	x = 020, 050, 100, 200
ME= x\r\n	Sets the mode	x = PECH, THRU <ul style="list-style-type: none"> • PECH = P/E (pulse/echo) • THRU = T/R (transmitter/receiver)
PF= x\r\n	Sets the pulse repetition frequency [PRF] in kHz or the trigger source	Setting PRF from internal trigger: x = 0.200, 0.300, ... 20.00 Switching to external trigger: x = EXBNC
IM= x\r\n	Sets the pulse type [Impulse]	x = SPIKE, RECT+, RECT-, RECT <ul style="list-style-type: none"> • RECT+ = unipolar positive • RECT- = unipolar negative • RECT = bipolar
VO= x\r\n	Sets the voltage in V ⓘ Available for "RECT" pulse only.	for "P/E" mode and 50 Ω damping: x = 10, 20, ... 100 for "T/R" mode and 1 k Ω damping: x = 20, 40, ... 200
BU= x\r\n	Sets the burst ⓘ Available for "RECT" pulse only.	x = 1, 2, ... 10
FR= x\r\n	Sets the frequency of the square pulse in kHz ⓘ Available for "RECT" pulse only.	x = 500 ... 8000

Examples

The following table contains examples of commands and responses:

Command	Response
EY=32\r\n	OK\r\n
EY=12\r\n	ER\r\n

3.8.3 Queries

Description

The RS-232 interface may be used to send queries for determining the parameter values currently set in the SONO-PR 200.

After sending a query, the SONO-PR 200 will return one of the following responses:

Query	Response
Valid	Queried parameter including value Example: PRF = 10.00 KHz\r\n
Invalid	ER\r\n

For sending a query, the respective parameter must be used in the following syntax:
PARAMETER=?\r\n

Available queries and responses

The following table contains a list of all available queries and the respective responses:

Query	Description	Response
DG?\r\n	Damping query	DAMPING = x Ohm\r\n
EY?\r\n	Energy query ⓘ Available for "SPIKE" pulse only.	ENERGY = x uJ\r\n
GN?\r\n	Gain query	GAIN = x dB\r\n
HF?\r\n	High pass filter [HPF] query	for HPF = 100 kHz: HP FILT = 100 KHz\r\n for HPF > 100 kHz: HP FILT = x MHz\r\n
IA?\r\n	Input attenuation query	ATTENUATORS = x dB\r\n
OA?\r\n	Output attenuation query	ATTENUATORS = x dB\r\n

Query	Description	Response
LF?\r\n	Low pass filter [LPF] query	LP FILT = x MHz\r\n
ME?\r\n	Mode query	MODE = x \r\n x = PECH or THRU
PF?\r\n	Pulse repetition frequency [PRF] query	PRF = x KHz\r\n
IM?\r\n	Pulse type query	IMPULSE = x\r\n x = SPIKE, RECT+, RECT-, RECT
VO?\r\n	Voltage query ⓘ Available for "RECT" pulse only.	VOLTAGE = x V\r\n
BU?\r\n	Burst query ⓘ Available for "RECT" pulse only.	BURST = x\r\n
FR?\r\n	Frequency (square pulse) query ⓘ Available for "RECT" pulse only.	FREQUENCY = x KHz\r\n
VN?\r\n	Device identification query	SONO-PR 200 VERSION x\r\n x = firmware version number

Examples

The following table contains examples of queries and responses:

Query	Response
PF=?\r\n	PRF = 10.00 KHz\r\n
PR=?\r\n	ER\r\n

3.8.4 Parameter dependencies

Depending on the values of set parameters, some parameters will automatically be constrained by the SONO-PR 200.

If the SONO-PR 200 is controlled by software, all depending parameters should be queried after parameter setting to ensure the software update.

Parameter to be set	Depending parameter to be queried
Mode	Damping, Voltage, PRF
Impulse	Damping, Voltage, PRF
Damping	Voltage, PRF
Voltage	PRF
Burst	PRF
Frequency	PRF

Example

Query: PF?\r\n

Response: PRF = 6.400 KHz\r\n

Query: BU?\r\n

Response: 1\r\n

Command: BU=10\r\n

Response: OK\r\n

Query: PF?\r\n

Response: PRF = 0.600 KHz\r\n

4 Preparing a work order

This section describes preparations and settings that are necessary and/or useful before processing a work order. The content structure and order follow the typical (recommended) work flow.

Before you begin

Before starting up the device, make sure that:

- the device has no visible damage,
- the connection cables have no visible damage,
- all connection cables are fitted with matching plugs and
- none of the probes shows visible damage.

4.1 Positioning

Location

Always make sure that the installation site adheres to the stipulated ambient conditions (see "7 Technical data", page 42).

Positioning options

Usage	Stipulation
As independent device	Place the SONO-PR 200 on a level, non-slip bearing surface.
Within a 19 inch equipment rack	Secure the SONO-PR 200 within the 19 inch equipment rack to prevent shifting, slipping or falling.

ⓘ Observe free accessibility!

Always position the device in a way that gives free access to the On/off switch and all connections.

4.2 Connecting external devices

Description

For triggering signals, an oscilloscope and a trigger source may be connected to the SONO-PR 200's back side (see "3.6 Back side of the device", page 15).

Connect the external equipment to the SONO-PR 200 depending on the kind of signal triggering.

Internal signal trigger

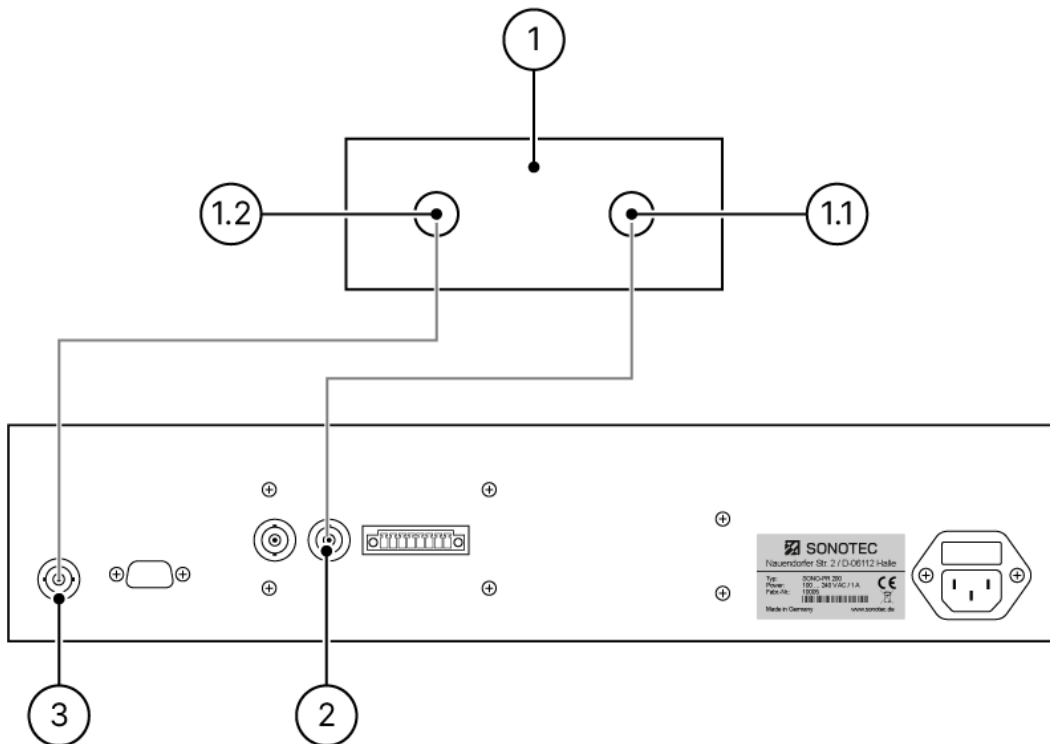

Figure 8: Connection diagram for internal signal trigger

No.	Description/function
1	Oszilloscope
1.1	Trigger signal input
1.2	Signal input
2	Trigger signal output
3	Signal output

External signal trigger

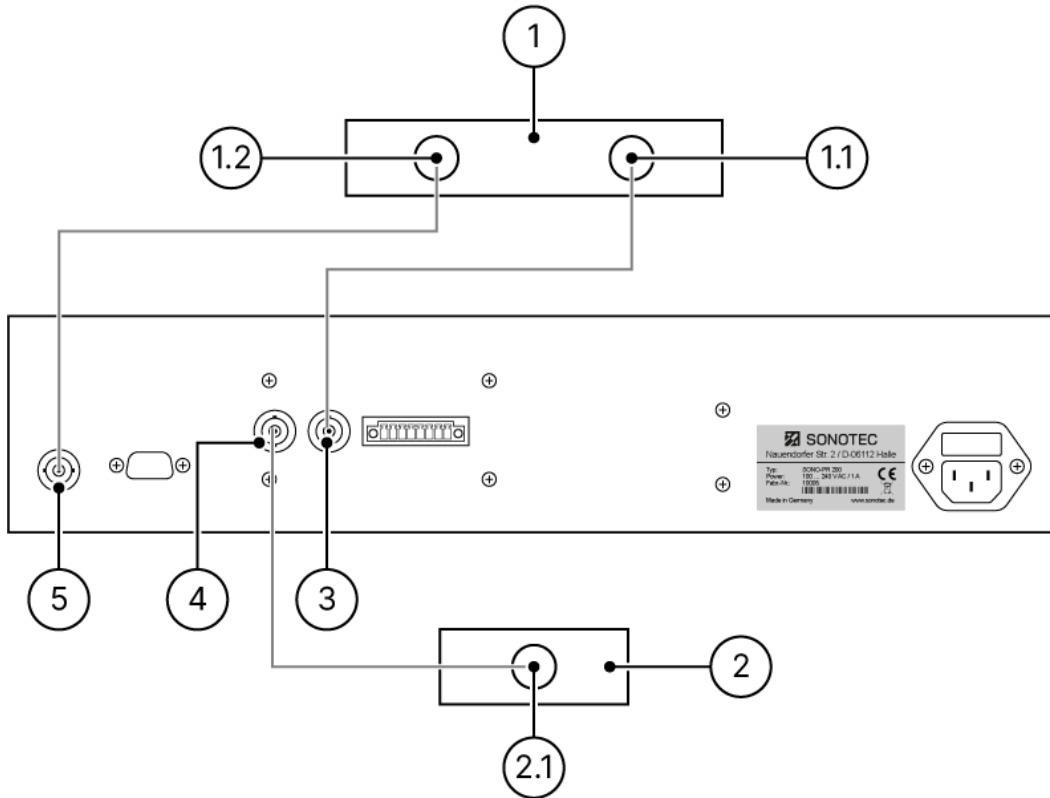

Figure 9: Connection diagram for external signal trigger

No.	Description/function
1	Oszilloscope
1.1	Trigger signal input
1.2	Signal input
2	Trigger source
2.1	Trigger signal output
3	Trigger signal output
4	Trigger signal input
5	Signal output

4.3 Adjusting the brightness of the touch screen

Description

The brightness of the touch panel screen may be adjusted to the brightness of the surroundings/work place in predefined increments.

Procedure

1. Tap the "Brightness" button on the "Main menu" screen.

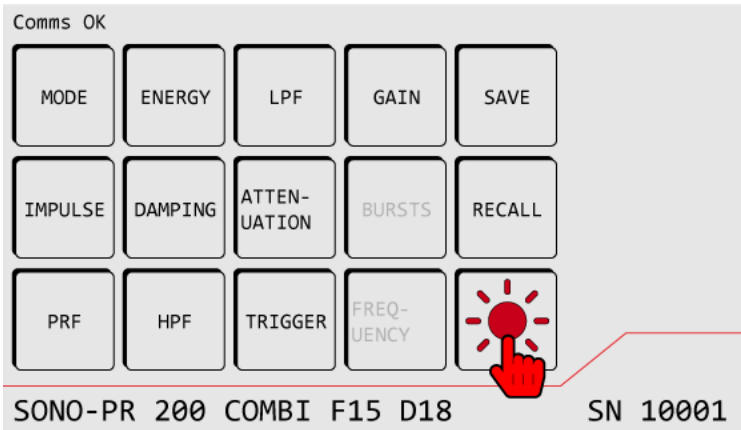

→ The "Brightness" screen opens.

2. Adjust the brightness with the **+** and **-** buttons.

4.4 Setting the signal trigger

Description

Depending on the used connection diagram (internal/external), the signal trigger type must be set in the device. This setting must be updated after each change of connection.

Procedure

1. Tap the **Trigger** button on the "Main menu" screen.

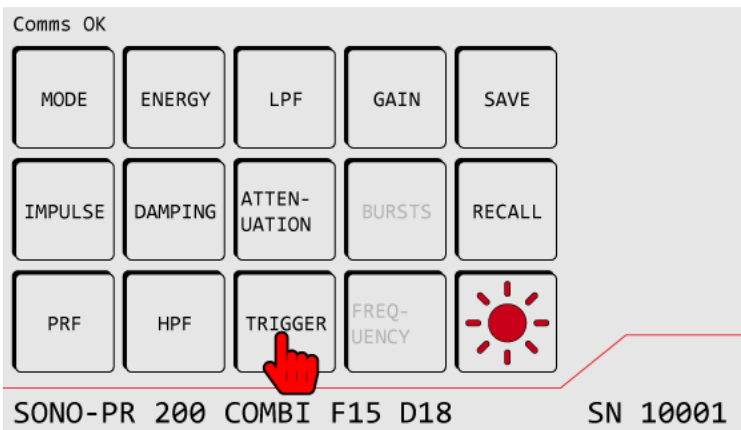

→ The "Settings" screen opens.

2. Set the type of signal trigger with the left/right buttons of the directional pad.
 - Internal signal trigger: INTERN
 - External signal trigger: EXTERN

ⓘ Set the signal trigger according to the applicable connection diagram (see "4.2 Connecting external devices", page 28).

Constraint of the pulse repetition frequency with external trigger source

Trigger input signals above the maximum permissible value will automatically be constrained to the maximum permissible value by the device. The actual current PRF will be displayed on the device's touch screen under PRF.

Examples

Trigger in = 40 kHz

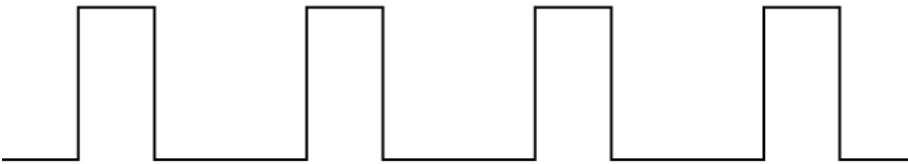

Trigger out = 20 kHz



Trigger in = 60 kHz

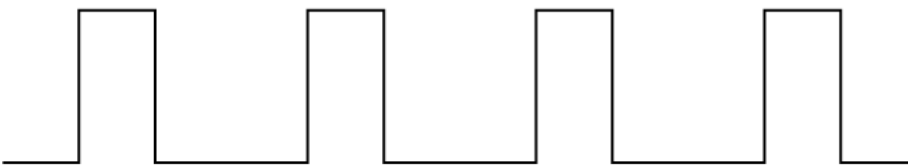

Trigger out = 20 kHz



4.5 Setting the operation mode

Description

Depending on the probe to be connected, the operating mode must be adapted.

Procedure

1. Tap the **Mode** button on the “Main menu” screen.

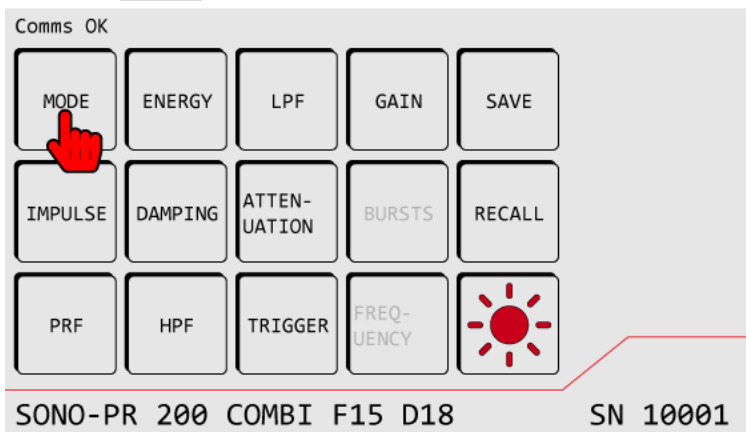

→ The “Settings” screen opens.

2. Set the particular operation mode with the left/right buttons of the directional pad.
 - T/R probe: T/R (transmitter/receiver)
 - Straight beam probe: P/E (pulse/echo)

4.6 Setting the transmitter pulse type

Description

Before connecting a probe, a suitable transmitter pulse type must be set.

CAUTION

Destruction of probes due to transmitter pulses with wrong polarity!

The use of transmitter pulses with the wrong polarity may lead to destruction of probes.

- Before setting the transmitter pulse, always check the manufacturer's instructions for the particular probe.
- Before connecting a probe, always set the suitable transmitter pulse type.

Procedure

1. Tap the **Impulse** button on the “Main menu” screen.

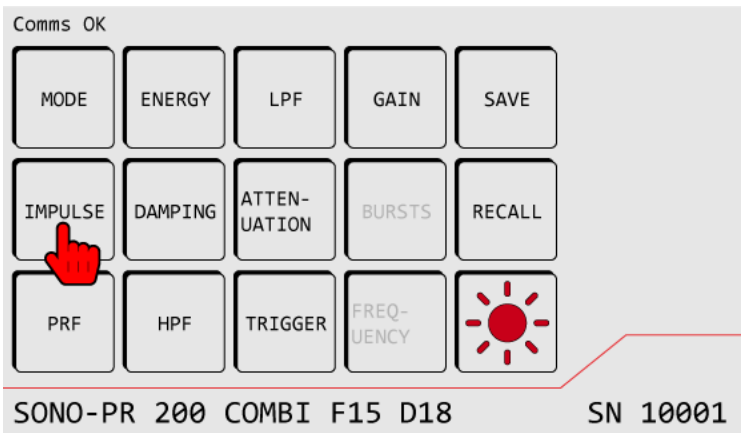

→ The “Settings” screen opens.

2. Set the particular transmitter pulse type with the left/right buttons of the directional pad.

5 Performing a work order

This section describes tasks that are necessary and/or useful for processing a work order. The content structure and order follow the typical (recommended) work flow.

Before you begin

Before beginning a work order, please always check that:

- the device has no visible damage,
- the connection cables have no visible damage,
- all connection cables are fitted with matching plugs and
- none of the probes shows visible damage.

5.1 Connecting a probe (SONOTEC probes)

Validity and application

The following connection diagrams only apply to SONOTEC GmbH probes.

CAUTION

Destruction of probes due to transmitter pulses with wrong polarity!

The use of transmitter pulses with the wrong polarity may lead to destruction of probes.

- Before setting the transmitter pulse, always check the manufacturer's instructions for the particular probe.
- Before connecting a probe, always set the suitable transmitter pulse type.

CAUTION

Faulty readings possible due to connection mix-up!

Incorrect connections may lead to faulty readings.

- Always make sure to connect the probe according to instructions.
- For connection of a probe, please refer to the description of the device front side (see "3.5 Front side of the device", page 14).

Connect the probe to the SONO-PR 200 depending on the probe type.

T/R probe

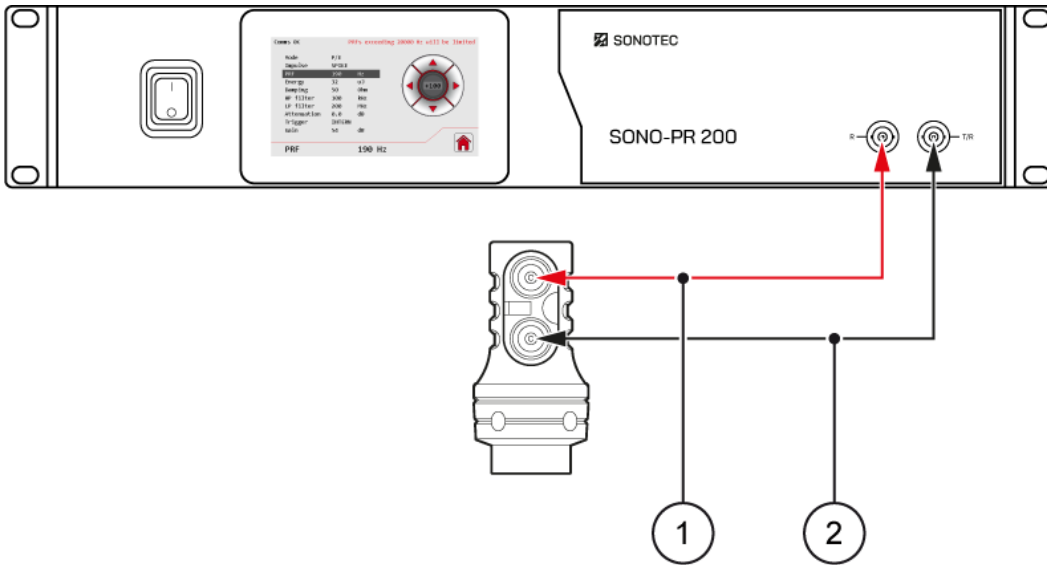

Figure 10: T/R probe connection diagram

No.	Description/function
1	Receiver (red connector)
2	Transmitter (black connector)

Straight beam probe (with/without delay)

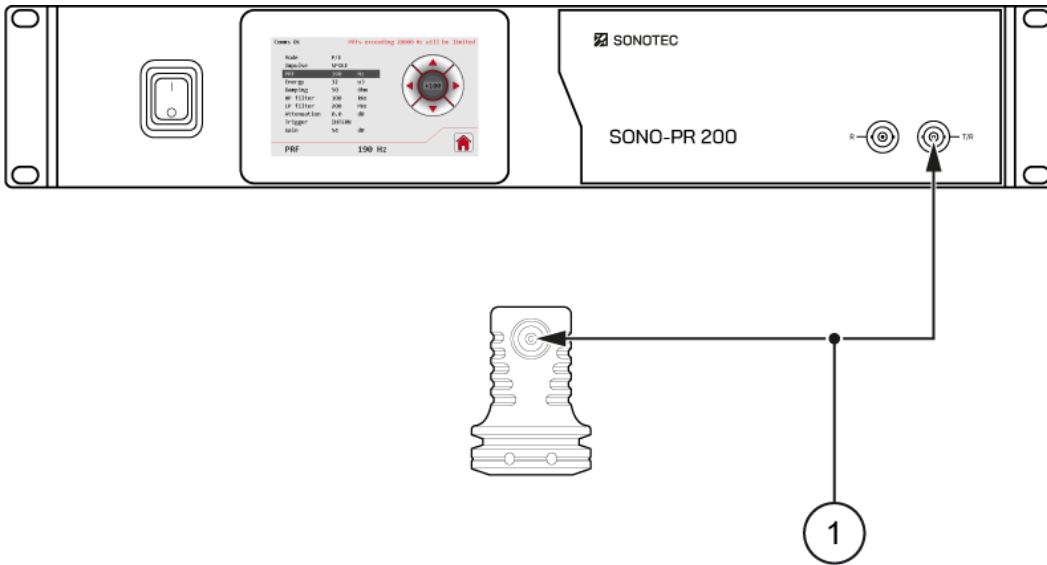

Figure 11: Straight beam probe connection diagram

No.	Description/function
1	Transmitter/receiver (black connector)

5.2 Setting up parameters

Description

The values of all configurable parameters may be adjusted to the task at hand.

CAUTION

Transmitter trigger suspension

Switching/modifying the transmitting voltage or the transmitter type may lead to a suspension of the transmitter trigger for several seconds.

- After switching/modification, please wait until the set transmitting voltage is stable and the safety lock of the transmitter has been released.

Procedure

1. Tap the button of the particular parameter in the "Main menu" screen.
→ The "Settings" screen opens.
2. Set the particular value with the left/right buttons of the directional pad.

5.3 Saving settings

Description

The set values of all parameters may be saved in a setup. Thus, settings for differing tasks may be saved in the device and loaded when needed. SONO-PR 200 offers 15 different storage locations for setups.

Procedure

1. Tap the **Save** button on the “Main menu” screen.

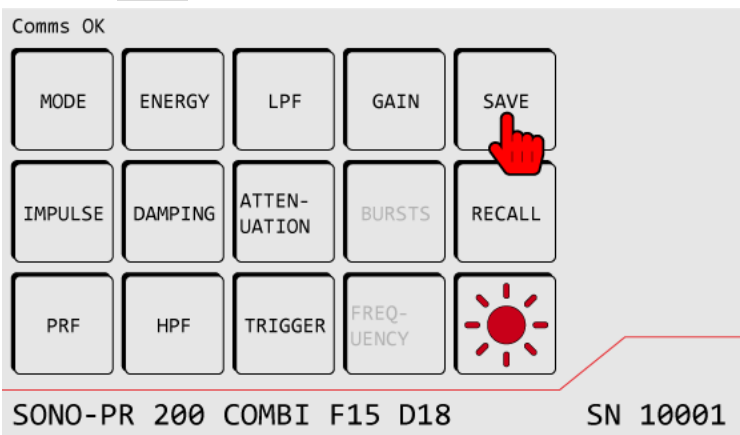

→ The “Setups” screen opens.

2. In the “Setups” screen, tap on a setup without saved settings.

→ All current settings will be saved in the selected setup. The selected setup is marked with an asterisk.

ⓘ Setups without saved settings are not marked.

5.4 Overwriting an existing setup

Description

Setups with saved settings may be overwritten by modified/new settings.

ATTENTION

Data loss during overwrite!

The settings will be overwritten without confirmation prompt.

- Before overwriting settings, please make sure that the existing settings may indeed be overwritten.

Procedure

1. Tap the **Save** button on the “Main menu” screen.

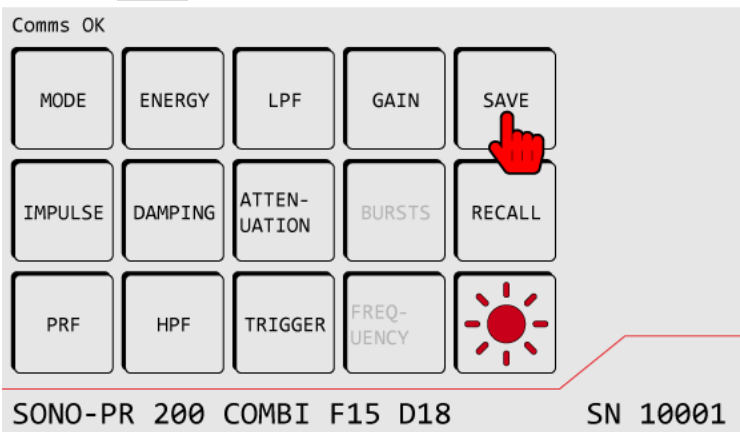

→ The “Setups” screen opens.

2. In the “Setups” screen, tap on a setup with previously saved settings.
→ All existing settings of the selected setup will be overwritten by the current settings.

ⓘ Setups with saved settings are marked with an asterisk.

5.5 Loading settings

Description

All setups saved in the device may be loaded when needed. Thus, it is not necessary to reset each parameter individually. Besides, it is possible to use predefined settings for recurring tasks.

Procedure

1. Tap the **Recall** button on the “Main menu” screen.

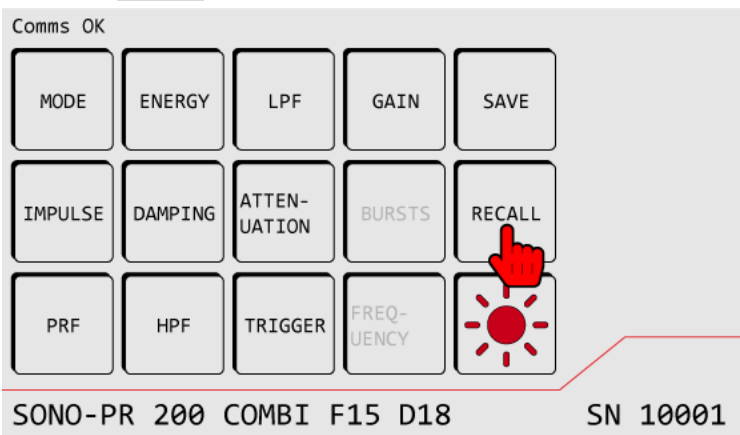

→ The “Setups” screen opens.

2. In the “Setups” screen, tap on the setup with the particular settings.
→ All saved settings are loaded in the device.

ⓘ Setups with saved settings are marked with an asterisk.

6 Maintaining the system

This section contains instructions, descriptions and notes on maintenance and care.

6.1 Replacing fuses

Position of the fuses

The fuses are located on the back side of the device above the mains voltage connection (see "3.6 Back side of the device", page 15).

⚠ DANGER

Risk of death by electrocution!

Body contact with live parts can lead to death or serious injuries as well as the destruction or damaging of components.

- Prior to replacing the fuses, please make sure that the device is de-energized and secured against unintentional starting (restart).

Before you begin

1. Turn off the SONO-PR 200.
2. Remove the mains cable.
3. Remove all connected cables from the SONO-PR 200.

Procedure

1. Pull the fuse holder from the slot.

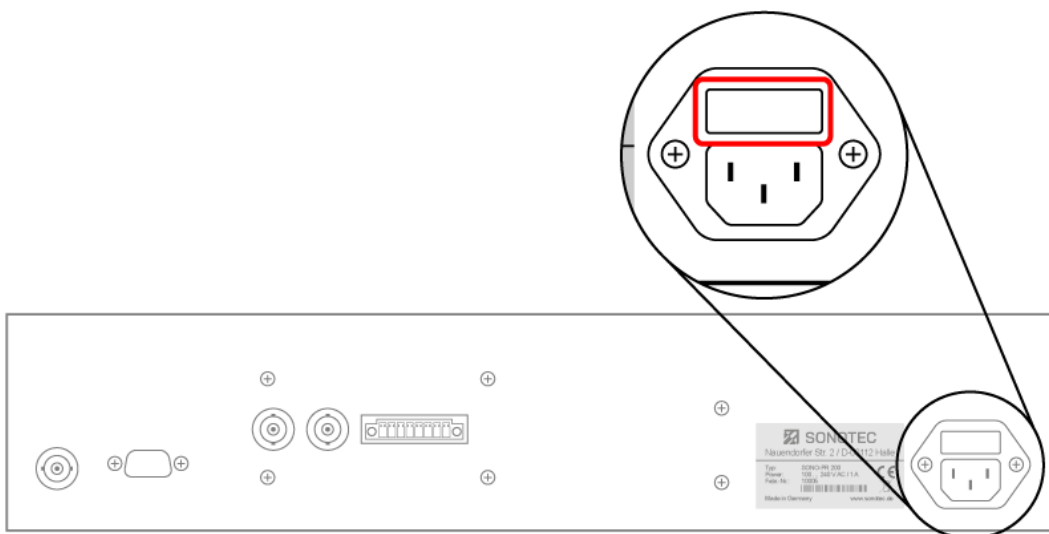

2. Replace the fuse or fuses.

ⓘ Only use fuses that comply with the stipulated ratings!

3. Push the fuse holder into the slot until it snaps in.

6.2 Cleaning

Guidelines

Do not open the product! The product contains no parts to be cleaned by the operator.

Suitable cleaning products

Only clean the product on the outside with soft, lint-free cloth.

For hard-to-remove dirt and/or fatty deposits, only use cleaning agents approved by the manufacturer.

ATTENTION

Check the compatibility of used cleaning agents!

The compatibility of all cleaning agents with used materials and colors must be confirmed and approved by SONOTEC GmbH or the respective supplier.

Unsuitable cleaning agents

Do not clean the product with:

- scratchy, aggressive, solvent-containing or benzine-containing cleaning agents,
- pressured air, high-pressure cleaner or other kinds of cleaning machine.

After cleaning

After cleaning the device, make sure that:

- cables, connectors and fittings are free of cleaning agents and
- cables, wires, connectors and electrical components are dry.

6.3 Maintenance

Guidelines

Do not open the device! The device contains no parts to be maintained or repaired by the operator.

7 Technical data

General data	
Article number	200 09 0001: SONO-PR 200 Spike Pulser – Rack mount 200 09 0009: SONO-PR 200 Spike Pulser – Desktop 200 09 0015: SONO-PR 200 Combi Pulser – Desktop 200 09 0016: SONO-PR 200 Combi Pulser – Rack mount
Dimensions	19", 2 U (rack units)
Weight	5.5 kg
Operation modes	P/E (pulse/echo) T/R (Through transmission, transmitter/reciever separated)
Number of channels	1
Display	Type: TFT Dimension: 4.3" Resolution: 480 × 272 Pixel
Electrical data	
Power supply	110/220 VAC, 1 A, 50/60 Hz
Power consumption	110/220 VAC, 1 A, 50/60 Hz
Connections and interfaces	
Electrical connection	IEC socket C14
Communication	RS-232 (9 pin D-sub male)
Probe connectors, Analog HF Out, Trigger I/O	BNC connector
Digital I/O	On request only Up to 8 Phoenix MCV 1,5/ 8-GF-3,81

Spike pulser	
Open circuit voltage	277 V
Energy	1 2 4 8 16 32 μ J
Rise time	< 1 ns
Damping	6.5 10 16 20 26 30 40 50 Ω
Pulse repetition frequency	Range: 10 Hz ... 20 kHz Increment: 10 100 1000 Hz
Square wave pulser	
Voltage	10 ... 100 V (at damping 50 Ω) 20 ... 200 V (at damping 1 k Ω)
Polarity	Unipolar+ Unipolar- Bipolar
Pulse width	63 ... 1000 ns (corresponds to 500 kHz ... 8 MHz frequency range)
Pulses per burst	1 ... 10
Damping	50 Ω 1 k Ω (at TR mode)
Pulse repetition frequency	Range: 10 Hz ... 20 kHz Increment: 10 100 1000 Hz
	ⓘ The maximum pulse repetition frequency depends on the other device settings.
Receiver	
Gain	26 40 54 dB
Attenuation	Range: 0 ... 65.5 dB Increment: 0.5 6 dB
Input impedance	50 Ω
Bandwidth	100 kHz ... 200 MHz (-3 dB)
High-pass filter	100 kHz 1 MHz 3 MHz 10 MHz
Low-pass filter	200 MHz 100 MHz 50 MHz 20 MHz

Receiver

Equivalent input noise level	2 nV / $\sqrt{\text{Hz}}$ (gain: 54 dB; attenuation: 0 dB; full bandwidth)
Crosstalk attenuation	> 80 dB at 10 MHz

Trigger

Source	Internal or external
Max. trigger rate	20 kHz
Output level	5 V
Output impulse duration	20 μs

Ambient conditions

Operating temperature	0 °C ... +60 °C
Storage temperature	-20 °C ... +80 °C
Protection type	IP20

8 Disposal

Recycling and taking back of used equipment

Electrical and electronic devices may pose a risk to health and the environment if disposed of incorrectly. They cannot therefore be disposed of as domestic waste according to WEEE Directive 2012/19/EU (Waste Electrical and Electronic Equipment Directive). Instead they must be taken to designated collecting points or returned to the manufacturer.

The following symbol indicates the legal duty to dispose of electronic devices as stipulated.

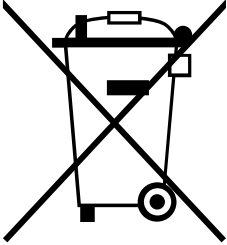

They must undergo specified recycling processes (e. g., with respect to batteries or circuit boards) which enable safe, environmentally compatible re-use or separate disposal of different device elements.

The return of used devices is regulated differently in different places. Find out from your local council about the return conditions for commercially used electronic devices. The device, including rechargeable battery, contains no toxic substances requiring separate identification for disposal such as mercury (Hg), cadmium (Cd), lead (Pb) or chrome 6 (e. g., in plated parts or circuit boards).

9 Warranty

Condition at delivery

All products and accessories have been tested thoroughly before they leave the factory, are state-of-the-art products at the time of delivery and adhere to all applicable safety regulations.

Warranty

During the warranty period, SONOTEC GmbH will eliminate all deficiencies caused by material or manufacturing faults free of charge. SONOTEC GmbH will at its own discretion offer warranty by reparation or replacement of faulty products.

Exceptions

Internal accumulators as well as damage caused by unintended use, by wear or by manipulation of the product are exempt from warranty. The warranty also does not cover those faults that affect value or usability of the product to a negligible amount.

Responsibility of the user/operator

It lies within the responsibility of the users to ensure that the product has been installed and set-up properly and is used in a manner that does not impair safe operation.

Operating errors

Operating errors can never be completely ruled out by the manufacturer. SONOTEC GmbH is in no way liable for any direct or indirect damage caused by operating errors (e.g. damage on software and/or hardware, damage by downtime, damage by malfunction as well as damage or loss of measurement and test data).

Quality of captured data

The determination of valid test results, their interpretation and the actions derived therefrom are exclusively subject to the personal responsibility of the users. SONOTEC GmbH does not guarantee the correctness of determined test values and/or test results. SONOTEC GmbH does not assume liability for any faults or damages that might occur due to further use of determined test and measurement values.

10 Manufacturer information

Copyright

© SONOTEC GmbH

All rights reserved.

All contents of this document are property of SONOTEC GmbH and are protected by copyright. Duplication, modification and/or distribution in any form, particularly for reprint, for photographic, mechanical or electronic reproduction or in the form of saving in data processing systems or data networks is forbidden without written approval by SONOTEC GmbH.

Certifications and registrations

- Quality management according to ISO 9001:2015
(Certificate Registration No.: 091006014)
- Registration according to ElektroG at the "stiftung elektro-altgeräte register" (ear):
WEEE Reg. No. DE 22125904

Contact

Manufacturer

SONOTEC GmbH
Nauendorfer Str. 2
06112 Halle (Saale), Germany
Phone: +49 345 13317-0
mySONAPHONE@sonotec.de
www.sonotec.eu

USA

SONOTEC US Inc.
190 Blydenburgh Rd.
Suite 8, 2nd Floor
Islandia, New York 11749, USA
Phone: +1 631 4154758
sales@sonotecusa.com
www.sonotecusa.com

EU Declaration of Conformity

We

SONOTEC GmbH

Nauendorfer Str. 2
06112 Halle (Saale)
Germany

declare under our sole responsibility, that the product

SONO-PR 200

to which this declaration relates is in conformity with the following standards, including the valid changes at time of declaration:

2011/65/EU Restriction of Hazardous Substances (RoHS)

2014/30/EU Electromagnetic Compatibility

2014/35/EU Low Voltage Directive

in agreement with the following standards:

DIN EN 61326-1:2013

Electrical equipment for measurement, control and laboratory use – EMC requirements –
Part 1: General requirements

DIN EN 55011:2011

Industrial, scientific and medical equipment - Radio-frequency disturbance characteristics -
Limits and methods of measurement

DIN EN 55011:2018

Industrial, scientific and medical equipment - Radio-frequency disturbance characteristics -
Limits and methods of measurement

DIN EN 61010-1:2011

Safety requirements for electrical equipment for measurement, control and laboratory use –
Part 1: General requirements

The SONO PR 200 is an ultrasonic pulser-receiver, which is suitable for a wide range of applications due to its very large bandwidth. Potential use cases range from the ultrasonic inspection of various materials (including wall thickness measurement) with both contact and squirter technology, all the way to acoustic microscopy. The SONO-PR 200 is ideal for the integration into automatic inspection systems; it is equipped with a variety of digital inputs, outputs and trigger ports and can also be controlled remotely over a serial interface.

The correspondence of the product mentioned above with the directives and laws of the EU directives is guaranteed by means of a quality management system.



Halle (Saale), 14th May 2021

A handwritten signature in blue ink, appearing to read 'M. Münch', is written above the printed name.

Michael Münch
Managing Director